

NPA

PRODUKTNEUHEITEN

WERKZEUGAUFNAHMEN

06-2020

APRIL 2020 • METRISCH

SEITE 1 / 11



HSK A100 SEM32X100C



HSK A100 SEM32X78X100C

Neue SEM-C-Aufsteckfräserdorne mit größerer Anlagefläche

NEU

SEM-C Aufsteckfräserdorne mit größerer Anlagefläche und innerer Kühlmittelzufuhr für den Einsatz mit unterschiedlichen Aufsteckfräsern.

Diese neuen Aufsteckfräserdorne wurden für den Einsatz in Bearbeitungszentren entwickelt, um eine hohe Präzision und optimale Zerspanleistung in der Schwerzerspannung zu erreichen.

Vorteile auf einen Blick

- Symmetrisches Design
- Innere Kühlmittelzufuhr
- Hohe Steifigkeit

Der Buchstabe 'C' kennzeichnet die Aufsteckfräserdorne mit innerer Kühlmittelzufuhr.

Beispiel: HSK A 63 SEM 320X78x50 C.

Verfügbarkeit und Preise

Siehe Preisliste in der Anlage.

Mit freundlichen Grüßen

ISCAR Germany GmbH

Erich Timons

CTO

Mitglied der Geschäftsleitung

Mit freundlichen Grüßen

ISCAR Germany GmbH

Herbert Volk

Produktmanager

C#-SEM-C

ISO 3937 Aufsteckfräserdorne CAMFIX (ISO 26623-1) mit Innenkühlung und CAMFIX Polygon-Aufnahme

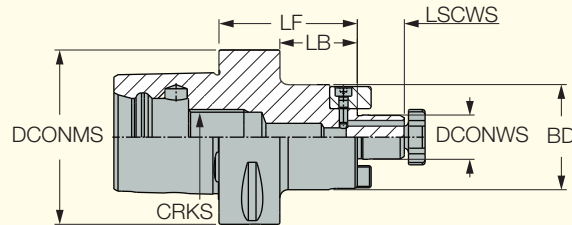
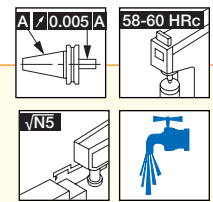

Bezeichnung	DCONMS	DCONWS	BD	LSCWS	LB	LF	CRKS	kg
C3 SEM 16X30 C	32.00	16.00	38.00	17.00	13.00	30.00	M12	0.30
C4 SEM16X32 C	40.00	16.00	38.00	17.00	12.00	32.00	M14	0.36
C4 SEM16X55 C	40.00	16.00	38.00	17.00	35.00	55.00	M14	0.54
C4 SEM22X40 C	40.00	22.00	47.00	19.00	20.00	40.00	M14	0.52
C4 SEM22X55 C	40.00	22.00	47.00	19.00	33.00	55.00	M14	0.80
C5 SEM16X35 C	50.00	16.00	38.00	17.00	15.00	35.00	M16	0.57
C5 SEM16X70 C	50.00	16.00	38.00	17.00	50.00	70.00	M16	0.85
C5 SEM22X35 C	50.00	22.00	47.00	19.00	15.00	35.00	M16	0.65
C5 SEM22X70 C	50.00	22.00	47.00	19.00	50.00	70.00	M16	1.09
C5 SEM27X40 C	50.00	27.00	58.00	21.00	20.00	40.00	M16	0.85
C5 SEM32X40 C	50.00	32.00	63.00	24.00	20.00	40.00	M16	0.93
C6 SEM16X100 C	63.00	16.00	38.00	17.00	78.00	100.00	M20	1.41
C6 SEM16X50 C	63.00	16.00	38.00	17.00	28.00	50.00	M20	1.00
C6 SEM22X100 C	63.00	22.00	47.00	19.00	78.00	100.00	M20	1.81
C6 SEM22X50 C	63.00	22.00	47.00	19.00	28.00	50.00	M20	1.15
C6 SEM27X100 C	63.00	27.00	58.00	21.00	78.00	100.00	M20	2.33
C6 SEM27X60 C	63.00	27.00	58.00	21.00	37.00	60.00	M20	1.52
C6 SEM32X60 C	63.00	32.00	66.00	24.00	37.00	60.00	M16	1.79
C6 SEM40X60 C	63.00	40.00	82.00	27.00	37.00	60.00	M20	2.34
C8 SEM16X50 C	80.00	16.00	38.00	17.00	20.00	50.00	M20	1.90
C8 SEM16X100C	80.00	16.00	38.00	17.00	70.00	100.00	M20	2.32
C8 SEM22X50 C	80.00	22.00	47.00	19.00	20.00	50.00	M20	2.01
C8 SEM22X100C	80.00	22.00	47.00	19.00	70.00	100.00	M20	2.88
C8 SEM27X50 C	80.00	27.00	58.00	21.00	20.00	50.00	M20	2.18
C8 SEM27X100C	80.00	27.00	58.00	21.00	70.00	100.00	M20	3.14
C8 SEM32X50 C	80.00	32.00	66.00	24.00	20.00	50.00	M16	2.28
C8 SEM32X100C	80.00	32.00	66.00	24.00	70.00	100.00	M16	3.56
C8 SEM32X78X50C	80.00	32.00	78.00	24.00	20.00	50.00	M20	2.20
C8 SEM32X78X100C	80.00	32.00	78.00	24.00	70.00	100.00	M20	4.50
C8 SEM40X60 C	80.00	40.00	82.00	27.00	30.00	60.00	M20	2.99

NEU
NEU

Ersatzteile



Bezeichnung	Klemmschraube	Mitnehmer	Schraube	Spannschlüssel	Sechskantschlüssel	Kühlrohr	Spannschlüssel 1
C3 SEM 16X30 C	M8 CLAMP SCREW SEM16	DR.DOG 8S	SR M3X10 DIN912	WRENCH M8 SEMC16*	HW 2.5*	COOLING TUBE C3*	WRENCH COOL TUBE C3*
C4 SEM16X32 C	M8 CLAMP SCREW SEM16	DR.DOG 8S	SR M3X10 DIN912	WRENCH M8 SEMC16*	HW 2.5*	COOLING TUBE C4*	WRENCH COOL TUBE C4*
C4 SEM16X55 C	M8 CLAMP SCREW SEM16	DR.DOG 8S	SR M3X10 DIN912	WRENCH M8 SEMC16*	HW 2.5*	COOLING TUBE C4*	WRENCH COOL TUBE C4*
C4 SEM22X40 C	M10 CLAMP SCREW SEM22	DR.DOG 10S	SR M4X10 DIN912	WRENCH M10 SEMC 22*	HW 3.0*	COOLING TUBE C4*	WRENCH COOL TUBE C4*
C4 SEM22X55 C	M10 CLAMP SCREW SEM22	DR.DOG 10S	SR M4X10 DIN912	WRENCH M10 SEMC 22*	HW 3.0*	COOLING TUBE C4*	WRENCH COOL TUBE C4*
C5 SEM16X35 C	M8 CLAMP SCREW SEM16	DR.DOG 8S	SR M3X10 DIN912	WRENCH M8 SEMC16*	HW 2.5*	COOLING TUBE C5*	WRENCH COOL TUBE C5*
C5 SEM16X70 C	M8 CLAMP SCREW SEM16	DR.DOG 8S	SR M3X10 DIN912	WRENCH M8 SEMC16*	HW 2.5*	COOLING TUBE C5*	WRENCH COOL TUBE C5*
C5 SEM22X35 C	M10 CLAMP SCREW SEM22	DR.DOG 10S	SR M4X10 DIN912	WRENCH M10 SEMC 22*	HW 3.0*	COOLING TUBE C5*	WRENCH COOL TUBE C5*
C5 SEM22X70 C	M10 CLAMP SCREW SEM22	DR.DOG 10S	SR M4X10 DIN912	WRENCH M10 SEMC 22*	HW 3.0*	COOLING TUBE C5*	WRENCH COOL TUBE C5*
C5 SEM27X40 C	M12 CLAMP SCREW SEM27	DR.DOG 12S	SR M5X12 DIN912	WRENCH M12 SEMC 27*	HW 4.0*	COOLING TUBE C5*	WRENCH COOL TUBE C5*
C5 SEM32X40 C	M16 CLAMP SCREW SEM32	DR.DOG 14X13S	SR M5X14 DIN912	WRENCH M16 SEMC 32*	HW 4.0*	COOLING TUBE C5*	WRENCH COOL TUBE C5*
C6 SEM16X100 C	M8 CLAMP SCREW SEM16	DR.DOG 8S	SR M3X10 DIN912	WRENCH M8 SEMC16*	HW 2.5*	COOLING TUBE C6*	WRENCH COOL TUBE C6*
C6 SEM16X50 C	M8 CLAMP SCREW SEM16	DR.DOG 8S	SR M3X10 DIN912	WRENCH M8 SEMC16*	HW 2.5*	COOLING TUBE C6*	WRENCH COOL TUBE C6*
C6 SEM22X100 C	M10 CLAMP SCREW SEM22	DR.DOG 10S	SR M4X10 DIN912	WRENCH M10 SEMC 22*	HW 2.5*	COOLING TUBE C6*	WRENCH COOL TUBE C6*
C6 SEM22X50 C	M10 CLAMP SCREW SEM22	DR.DOG 10S	SR M4X10 DIN912	WRENCH M10 SEMC 22*	HW 3.0*	COOLING TUBE C6*	WRENCH COOL TUBE C6*
C6 SEM27X100 C	M12 CLAMP SCREW SEM27	DR.DOG 12S	SR M5X12 DIN912	WRENCH M12 SEMC 27*	HW 4.0*	COOLING TUBE C6*	WRENCH COOL TUBE C6*
C6 SEM27X60 C	M12 CLAMP SCREW SEM27	DR.DOG 12S	SR M5X14 DIN912	WRENCH M12 SEMC 27*	HW 4.0*	COOLING TUBE C6*	WRENCH COOL TUBE C6*
C6 SEM32X60 C	M16 CLAMP SCREW SEM32	DR.DOG 14X13S	SR M5X14 DIN912	WRENCH M16 SEMC 32*	HW 4.0*	COOLING TUBE C6*	WRENCH COOL TUBE C6*
C6 SEM40X60 C	M20 CLAMP SCREW SEM40	DR.DOG 16X18S	SR M6X20 DIN912	WRENCH M20 SEMC 40*	HW 5.0*	COOLING TUBE C6*	WRENCH COOL TUBE C6*
C8 SEM16X50 C	M8 CLAMP SCREW SEM16	DR.DOG 8S	SR M3X10 DIN912	WRENCH M8 SEMC16*	HW 2.5*	COOLING TUBE C8*	WRENCH COOL TUBE C8*
C8 SEM16X100C	M8 CLAMP SCREW SEM16	DR.DOG 8S	SR M3X10 DIN912	WRENCH M8 SEMC16*	HW 2.5*	COOLING TUBE C8*	WRENCH COOL TUBE C8*
C8 SEM22X50 C	M10 CLAMP SCREW SEM22	DR.DOG 10S	SR M4X10 DIN912	WRENCH M10 SEMC 22*	HW 3.0*	COOLING TUBE C8*	WRENCH COOL TUBE C8*
C8 SEM22X100C	M10 CLAMP SCREW SEM22	DR.DOG 10S	SR M4X10 DIN912	WRENCH M10 SEMC 22*	HW 3.0*	COOLING TUBE C8*	WRENCH COOL TUBE C8*
C8 SEM27X50 C	M12 CLAMP SCREW SEM27	DR.DOG 12S	SR M5X12 DIN912	WRENCH M12 SEMC 27*	HW 4.0*	COOLING TUBE C8*	WRENCH COOL TUBE C8*
C8 SEM27X100C	M12 CLAMP SCREW SEM27	DR.DOG 12S	SR M5X12 DIN912	WRENCH M12 SEMC 27*	HW 4.0*	COOLING TUBE C8*	WRENCH COOL TUBE C8*
C8 SEM32X50 C	M16 CLAMP SCREW SEM32	DR.DOG 14X13S	SR M5X14 DIN912	WRENCH M16 SEMC 32*	HW 4.0*	COOLING TUBE C8*	WRENCH COOL TUBE C8*
C8 SEM32X100C	M16 CLAMP SCREW SEM32	DR.DOG 14X13S	SR M5X14 DIN912	WRENCH M16 SEMC 32*	HW 4.0*	COOLING TUBE C8*	WRENCH COOL TUBE C8*
C8 SEM32X78X50C	M16 CLAMP SCREW SEM32	DR.DOG 14X13S	SR M5X14 DIN912	WRENCH M16 SEMC 32*	HW 4.0*	COOLING TUBE C8*	WRENCH COOL TUBE C8*
C8 SEM32X78X100C	M16 CLAMP SCREW SEM32	DR.DOG 14X13S	SR M5X14 DIN912	WRENCH M16 SEMC 32*	HW 4.0*	COOLING TUBE C8*	WRENCH COOL TUBE C8*
C8 SEM40X60 C	M20 CLAMP SCREW SEM40	DR.DOG 16X18S	SR M6X20 DIN912	WRENCH M20 SEMC 40*	HW 5.0*	COOLING TUBE C8*	WRENCH COOL TUBE C8*

* Optional, bitte separat bestellen.

DIN 69871-SEM-C

ISO 3937 Aufsteckfräserdorne mit Innenkühlung,
DIN 69871, Form ADB

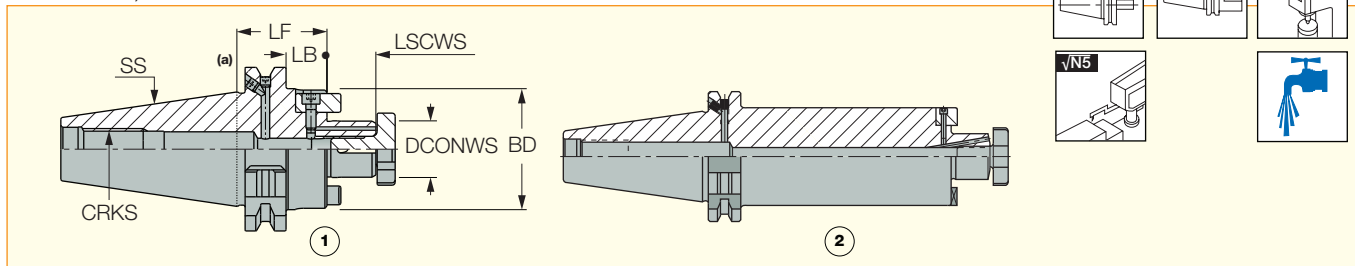

NEU
NEU

NEU
NEU

Bezeichnung	SS	DCONWS	BD	LF	LSCWS	LB	CRKS	kg	Abb.
DIN69871 40 SEM16X 35 C	40	16.00	38.00	35.00	17.00	15.9	M16	0.94	1.
DIN69871 40 SEM16X100 C	40	16.00	38.00	100.00	17.00	80.9	M16	1.48	1.
DIN69871 40 SEM22X 35 C	40	22.00	47.00	35.00	19.00	15.9	M16	1.02	1.
DIN69871 40 SEM22X100 C	40	22.00	47.00	100.00	19.00	80.9	M16	0.94	1.
DIN69871 40 SEM27X 60 C	40	27.00	58.00	60.00	21.00	40.9	M16	1.20	1.
DIN69871 40 SEM27X100 C	40	27.00	58.00	100.00	21.00	80.9	M16	2.32	1.
DIN69871 40 SEM32X 60 C	40	32.00	66.00	60.00	24.00	40.9	M16	1.69	1.
DIN69871 40 SEM32X78X50C	40	32.00	78.00	50.00	24.00	30.9	M16	1.75	1.
DIN69871 40 SEM32X78X100C	40	32.00	78.00	100.00	24.00	80.9	M16	3.58	1.
DIN69871 50 SEM16X 35 C	50	16.00	38.00	35.00	17.00	15.9	M24	2.68	1.
DIN69871 50 SEM16X100 C	50	16.00	38.00	100.00	17.00	80.9	M24	3.24	1.
DIN69871 50 SEM22X 35 C	50	22.00	47.00	35.00	19.00	15.9	M24	2.77	1.
DIN69871 50 SEM22X100 C	50	22.00	47.00	100.00	19.00	80.9	M24	3.59	1.
DIN69871 50 SEM22X48X200C ⁽¹⁾	50	22.00	48.00	200.00	19.00	181.0	M24	5.00	2.
DIN69871 50 SEM22X61X300C ⁽¹⁾	50	22.00	61.00	300.00	19.00	281.0	M24	8.75	2.
DIN69871 50 SEM27X 35 C	50	27.00	58.00	35.00	21.00	15.9	M24	2.88	1.
DIN69871 50 SEM27X100 C	50	27.00	58.00	100.00	21.00	80.9	M24	4.15	1.
DIN69871 50 SEM27X61X300C ⁽¹⁾	50	27.00	61.00	300.00	21.00	281.0	M24	8.70	2.
DIN69871 50 SEM32X 35 C	50	32.00	66.00	35.00	24.00	15.9	M24	3.00	1.
DIN69871 50 SEM32X100 C	50	32.00	66.00	100.00	24.00	80.9	M24	4.64	1.
DIN69871 50 SEM32X78X50C	50	32.00	78.00	50.00	24.00	30.9	M24	3.85	1.
DIN69871 50 SEM32X78X100C	50	32.00	78.00	100.00	24.00	80.9	M24	5.61	1.
DIN69871 50 SEM32X78X370C ⁽¹⁾	50	32.00	78.00	370.00	24.00	351.0	M24	15.42	2.

• (a) Wenn Typ B benötigt wird, muss die Verschlusschraube für Kühlung durch den Aufnahmeflansch entfernt werden (hierfür einen 2 mm Sechskantschlüssel verwenden).

⁽¹⁾ Symmetrisches Design.

Ersatzteile

Bezeichnung	Klemmschraube	Spannschlüssel	Drive Dog	Schraube
DIN69871 40 SEM16X 35 C	M8 CLAMP SCREW SEM16	WRENCH M8 SEMC16*	DR.DOG 85	SR M3X10 DIN912
DIN69871 40 SEM16X100 C	M8 CLAMP SCREW SEM16	WRENCH M8 SEMC16*	DR.DOG 85	SR M3X10 DIN912
DIN69871 40 SEM22X 35 C	M10 CLAMP SCREW SEM22	WRENCH M10 SEMC 22*	DR.DOG 105	SR M4X10 DIN912
DIN69871 40 SEM22X100 C	M10 CLAMP SCREW SEM22	WRENCH M10 SEMC 22*	DR.DOG 105	SR M4X10 DIN912
DIN69871 40 SEM27X 60 C	M12 CLAMP SCREW SEM27	WRENCH M12 SEMC 27*	DR.DOG 125	SR M5X12 DIN912
DIN69871 40 SEM27X100 C	M12 CLAMP SCREW SEM27	WRENCH M12 SEMC 27*	DR.DOG 125	SR M5X12 DIN912
DIN69871 40 SEM32X 60 C	M16 CLAMP SCREW SEM32	WRENCH M16 SEMC 32*	DR.DOG 14X135	SR M5X14 DIN912
DIN69871 40 SEM32X78X50C	M16 CLAMP SCREW SEM32	WRENCH M16 SEMC 32*	DR.DOG 14X135	SR M5X14 DIN912
DIN69871 40 SEM32X78X100C	M16 CLAMP SCREW SEM32	WRENCH M16 SEMC 32*	DR.DOG 14X135	SR M5X14 DIN912
DIN69871 50 SEM16X 35 C	M8 CLAMP SCREW SEM16	WRENCH M8 SEMC16*	DR.DOG 85	SR M3X10 DIN912
DIN69871 50 SEM16X100 C	M8 CLAMP SCREW SEM16	WRENCH M8 SEMC16*	DR.DOG 85	SR M3X10 DIN912
DIN69871 50 SEM22X 35 C	M10 CLAMP SCREW SEM22	WRENCH M10 SEMC 22*	DR.DOG 105	SR M4X10 DIN912
DIN69871 50 SEM22X100 C	M10 CLAMP SCREW SEM22	WRENCH M10 SEMC 22*	DR.DOG 105	SR M4X10 DIN912
DIN69871 50 SEM22X48X200C	M10 CLAMP SCREW SEM22	WRENCH M10 SEMC 22*	DR.DOG 105	SR M4X10 DIN912
DIN69871 50 SEM22X61X300C	M10 CLAMP SCREW SEM22	WRENCH M10 SEMC 22*	DR.DOG 105	SR M4X10 DIN912
DIN69871 50 SEM27X 35 C	M12 CLAMP SCREW SEM27	WRENCH M12 SEMC 27*	DR.DOG 125	SR M5X12 DIN912
DIN69871 50 SEM27X100 C	M12 CLAMP SCREW SEM27	WRENCH M12 SEMC 27*	DR.DOG 125	SR M5X12 DIN912
DIN69871 50 SEM27X61X300C	M12 CLAMP SCREW SEM27	WRENCH M12 SEMC 27	DR.DOG 125	SR M5X12 DIN912
DIN69871 50 SEM32X 35 C	M16 CLAMP SCREW SEM32	WRENCH M16 SEMC 32*	DR.DOG 14X135	SR M5X14 DIN912
DIN69871 50 SEM32X100 C	M16 CLAMP SCREW SEM32	WRENCH M16 SEMC 32*	DR.DOG 14X135	SR M5X14 DIN912
DIN69871 50 SEM32X78X50C	M16 CLAMP SCREW SEM32	WRENCH M16 SEMC 32*	DR.DOG 14X135	SR M5X14 DIN912
DIN69871 50 SEM32X78X100C	M16 CLAMP SCREW SEM32	WRENCH M16 SEMC 32*	DR.DOG 14X135	SR M5X14 DIN912
DIN69871 50 SEM32X78X370C	M16 CLAMP SCREW SEM32	WRENCH M16 SEMC 32*	DR.DOG 14X165	SR M5X20 DIN912

* Optional, bitte separat bestellen.

HSK A-SEM-C

Aufsteckfräserdorn mit Innenkühlung,
DIN 69893, Form A

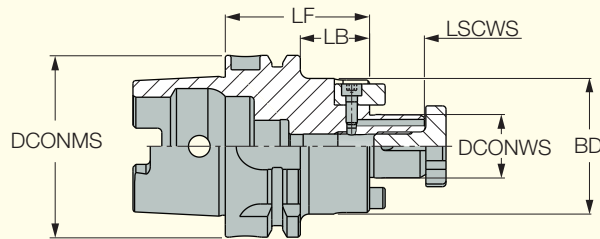
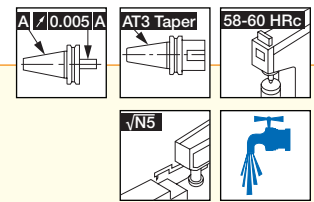





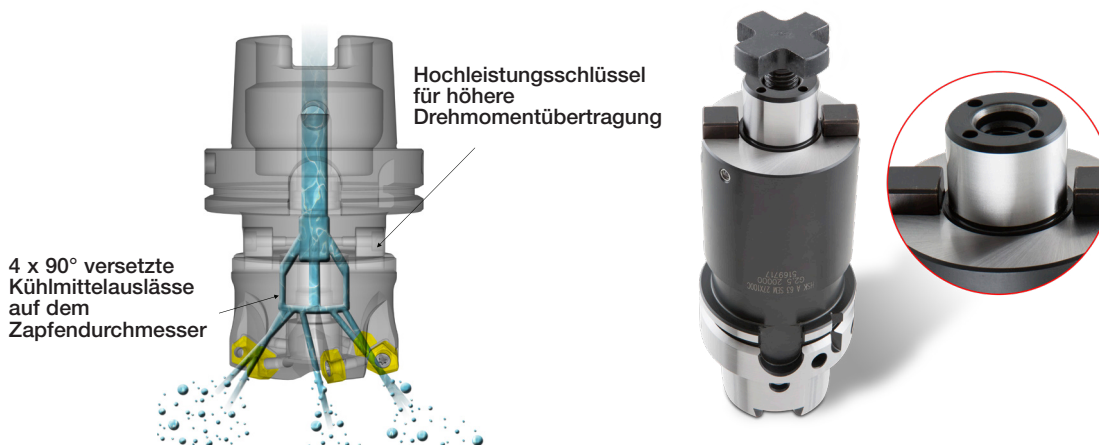

Bezeichnung	DCONMS	DCONWS	BD	LF	LB	LSCWS	kg
HSK A63 SEM16X50C	63.00	16.00	38.00	50.00	24.0	17.00	0.84
HSK A63 SEM16X100C	63.00	16.00	38.00	100.00	74.0	17.00	1.16
HSK A63 SEM22X50C	63.00	22.00	47.00	50.00	24.0	19.00	0.97
HSK A63 SEM22X100C	63.00	22.00	47.00	100.00	74.0	19.00	1.68
HSK A63 SEM27X60C	63.00	27.00	58.00	60.00	34.0	21.00	1.28
HSK A63 SEM27X100C	63.00	27.00	58.00	100.00	74.0	21.00	2.00
HSK A63 SEM32X60C	63.00	32.00	66.00	60.00	34.0	24.00	1.38
NEU HSK A63 SEM32X78X60C	63.00	32.00	78.00	60.00	34.0	24.00	1.90
NEU HSK A63 SEM32X78X100C	63.00	32.00	78.00	100.00	74.0	24.00	3.33
HSK A100 SEM16X50C	100.00	16.00	38.00	50.00	21.0	17.00	2.20
HSK A100 SEM16X100C	100.00	16.00	38.00	100.00	71.0	17.00	2.59
HSK A100 SEM22X50C	100.00	22.00	47.00	50.00	21.0	19.00	1.50
HSK A100 SEM22X100C	100.00	22.00	47.00	100.00	71.0	19.00	3.15
HSK A100 SEM27X50C	100.00	27.00	58.00	50.00	21.0	21.00	2.70
HSK A100 SEM27X100C	100.00	27.00	58.00	100.00	71.0	21.00	3.46
HSK A100 SEM32X50C	100.00	32.00	66.00	50.00	21.0	24.00	2.60
NEU HSK A100 SEM32X100C	100.00	32.00	66.00	100.00	71.0	24.00	2.81
NEU HSK A100 SEM32X78X60C	100.00	32.00	78.00	60.00	31.0	24.00	3.33
NEU HSK A100 SEM32X78X100C	100.00	32.00	78.00	100.00	71.0	24.00	4.80

• Bei HSK-Kühlung durch die Spindel muss generell ein Kühlmittelrohr verwendet werden (muss separat bestellt werden).

Vorteile

- Standzeitverlängerung (insbesondere beim Fräsen von Titan und Aluminium)
- Symmetrisches Design – für hohe Drehzahlen
- Hochleistungsschlüssel für höhere Drehmomentübertragung
- Deutlich verbesserte Spanabfuhr
- Verbesserte Oberflächenqualität



Ersatzteile						
Bezeichnung	Spannschlüssel	Klemmschraube	Mitnehmer	Schraube	Kühlrohr	Spannschlüssel 1
HSK A63 SEM16X50C		M8 CLAMP SCREW SEM16	DR.DOG 8S	SR M3X10 DIN912	COOLING TUBE HSK A63*	WRENCH COOL TUBE HSK63*
HSK A63 SEM16X100C		M8 CLAMP SCREW SEM16	DR.DOG 8S	SR M3X10 DIN912	COOLING TUBE HSK A63*	WRENCH COOL TUBE HSK63*
HSK A63 SEM22X50C		M10 CLAMP SCREW SEM22	DR.DOG 10S	SR M4X10 DIN912	COOLING TUBE HSK A63*	WRENCH COOL TUBE HSK63*
HSK A63 SEM22X100C		M10 CLAMP SCREW SEM22	DR.DOG 10S	SR M4X10 DIN912	COOLING TUBE HSK A63*	WRENCH COOL TUBE HSK63*
HSK A63 SEM27X60C		M12 CLAMP SCREW SEM27	DR.DOG 12S	SR M5X12 DIN912	COOLING TUBE HSK A63*	WRENCH COOL TUBE HSK63*
HSK A63 SEM27X100C		M12 CLAMP SCREW SEM27	DR.DOG 12S	SR M5X12 DIN912	COOLING TUBE HSK A63*	WRENCH COOL TUBE HSK63*
HSK A63 SEM32X60C		M16 CLAMP SCREW SEM32	DR.DOG 14X13S	SR M5X14 DIN912	COOLING TUBE HSK A63*	WRENCH COOL TUBE HSK63*
HSK A63 SEM32X78X60C	WRENCH M16 SEMC 32*	M16 CLAMP SCREW SEM32	DR.DOG 14X13S	SR M5X14 DIN912	COOLING TUBE HSK A63*	WRENCH COOL TUBE HSK63*
HSK A63 SEM32X78X100C	WRENCH M16 SEMC 32*	M16 CLAMP SCREW SEM32	DR.DOG 14X13S	SR M5X14 DIN912	COOLING TUBE HSK A63*	WRENCH COOL TUBE HSK63*
HSK A100 SEM16X50C		M8 CLAMP SCREW SEM16	DR.DOG 8S	SR M3X10 DIN912	COOLING TUBE HSK A100*	WRENCH COOL TUBE HSK100*
HSK A100 SEM16X100C		M8 CLAMP SCREW SEM16	DR.DOG 8S	SR M3X10 DIN912	COOLING TUBE HSK A100*	WRENCH COOL TUBE HSK100*
HSK A100 SEM22X50C		M10 CLAMP SCREW SEM22	DR.DOG 10S	SR M4X10 DIN912	COOLING TUBE HSK A100*	WRENCH COOL TUBE HSK100*
HSK A100 SEM22X100C		M10 CLAMP SCREW SEM22	DR.DOG 10S	SR M4X10 DIN912	COOLING TUBE HSK A100*	WRENCH COOL TUBE HSK100*
HSK A100 SEM27X50C		M12 CLAMP SCREW SEM27	DR.DOG 12S	SR M5X12 DIN912	COOLING TUBE HSK A100*	WRENCH COOL TUBE HSK100*
HSK A100 SEM27X100C		M12 CLAMP SCREW SEM27	DR.DOG 12S	SR M5X12 DIN912	COOLING TUBE HSK A100*	WRENCH COOL TUBE HSK100*
HSK A100 SEM32X50C		M16 CLAMP SCREW SEM32	DR.DOG 14X13S	SR M5X14 DIN912	COOLING TUBE HSK A100*	WRENCH COOL TUBE HSK100*
HSK A100 SEM32X100C		M16 CLAMP SCREW SEM32	DR.DOG 14X13S	SR M5X14 DIN912	COOLING TUBE HSK A100*	WRENCH COOL TUBE HSK100*
HSK A100 SEM32X78X60C		M16 CLAMP SCREW SEM32	DR.DOG 14X13S	SR M5X14 DIN912	COOLING TUBE HSK A100*	WRENCH COOL TUBE HSK100*
HSK A100 SEM32X78X100C		M16 CLAMP SCREW SEM32	DR.DOG 14X13S	SR M5X14 DIN912	COOLING TUBE HSK A100*	WRENCH COOL TUBE HSK100*

* Optional, bitte separat bestellen.

BT-FC-SEM-C

Aufsteckfräserdorne mit Innenkühlung und Axialanlage

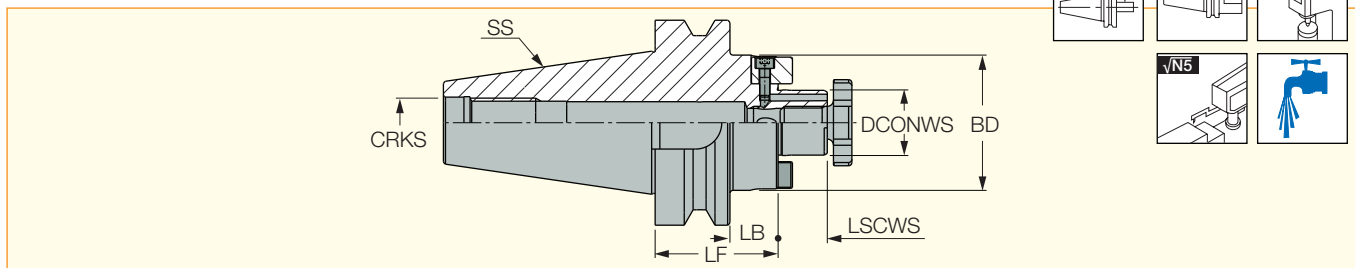

Bezeichnung	SS	DCONWS	BD	LF	LB	LSCWS	CRKS
BT30 FC SEM16X50C	30	16.00	38.00	50.00	28.0	17.00	M12
BT30 FC SEM22X50C	30	22.00	47.00	50.00	28.0	19.00	M12
BT30 FC SEM27X50C	30	27.00	58.00	50.00	28.0	21.00	M12
BT40 FC SEM16X60C	40	16.00	38.00	60.00	34.0	17.00	M16
BT40 FC SEM22X60C	40	22.00	47.00	60.00	34.0	19.00	M16
BT40 FC SEM22X120C	40	22.00	47.00	120.00	94.0	19.00	M16
BT40 FC SEM27X45C	40	27.00	58.00	45.00	19.0	21.00	M16
BT40 FC SEM32X60C	40	32.00	66.00	60.00	34.0	24.00	M16
BT40 FC SEM32X78X60C	40	32.00	78.00	60.00	34.0	24.00	M16
BT50 FC SEM16X75C	50	16.00	38.00	75.00	38.5	17.00	M24
BT50 FC SEM16X120C	50	16.00	38.00	120.00	83.5	17.00	M24
BT50 FC SEM22X75C	50	22.00	47.00	75.00	38.5	19.00	M24
BT50 FC SEM22X120C	50	22.00	47.00	120.00	83.5	19.00	M24
BT50 FC SEM27X60C	50	27.00	58.00	60.00	23.5	21.00	M24
BT50 FC SEM27X105C	50	27.00	58.00	105.00	68.5	21.00	M24
BT50 FC SEM32X60 C	50	32.00	66.00	60.00	11.5	24.00	M24
BT50 FC SEM32X78X60C	50	32.00	78.00	60.00	23.5	24.00	M24
BT50 FC SEM40X60 C	50	40.00	82.00	60.00	11.5	27.00	M24

NEU

NEU



Ersatzteile



Bezeichnung	Klemmschraube	Mitnehmer	Schraube	Spannschlüssel
BT30 FC SEM16X50C	M8 CLAMP SCREW SEM16	DR.DOG 8S	SR M3X10 DIN912	WRENCH M8 SEMC16*
BT30 FC SEM22X50C	M10 CLAMP SCREW SEM22	DR.DOG 10S	SR M4X10 DIN912	WRENCH M10 SEMC 22*
BT30 FC SEM27X50C	M12 CLAMP SCREW SEM27	DR.DOG 12S	SR M5X14 DIN912	WRENCH M12 SEMC 27*
BT40 FC SEM16X60C	M8 CLAMP SCREW SEM16	DR.DOG 8S	SR M3X10 DIN912	WRENCH M8 SEMC16*
BT40 FC SEM22X60C	M10 CLAMP SCREW SEM22	DR.DOG 10S	SR M4X10 DIN912	WRENCH M10 SEMC 22*
BT40 FC SEM22X120C	M10 CLAMP SCREW SEM22	DR.DOG 10S	SR M4X10 DIN912	WRENCH M10 SEMC 22*
BT40 FC SEM27X45C	M12 CLAMP SCREW SEM27	DR.DOG 12S	SR M5X14 DIN912	WRENCH M12 SEMC 27*
BT40 FC SEM32X60C	M16 CLAMP SCREW SEM32	DR.DOG 14X13S	SR M5X14 DIN912	WRENCH M16 SEMC 32*
BT40 FC SEM32X78X60C	M16 CLAMP SCREW SEM32	DR.DOG 14X13S	SR M5X14 DIN912	WRENCH M16 SEMC 32*
BT50 FC SEM16X75C	M8 CLAMP SCREW SEM16	DR.DOG 8S	SR M3X10 DIN912	WRENCH M8 SEMC16*
BT50 FC SEM16X120C	M8 CLAMP SCREW SEM16	DR.DOG 8S	SR M3X10 DIN912	WRENCH M8 SEMC16*
BT50 FC SEM22X75C	M10 CLAMP SCREW SEM22	DR.DOG 10S	SR M4X10 DIN912	WRENCH M10 SEMC 22*
BT50 FC SEM22X120C	M10 CLAMP SCREW SEM22	DR.DOG 10S	SR M4X10 DIN912	WRENCH M10 SEMC 22*
BT50 FC SEM27X60C	M12 CLAMP SCREW SEM27	DR.DOG 12S	SR M5X14 DIN912	WRENCH M12 SEMC 27*
BT50 FC SEM27X105C	M12 CLAMP SCREW SEM27	DR.DOG 12S	SR M5X14 DIN912	WRENCH M12 SEMC 27*
BT50 FC SEM32X60 C	M16 CLAMP SCREW SEM32	DR.DOG 14X13S	SR M5X14 DIN912	WRENCH M16 SEMC 32*
BT50 FC SEM32X78X60C	M16 CLAMP SCREW SEM32	DR.DOG 14X13S	SR M5X14 DIN912	WRENCH M16 SEMC 32*
BT50 FC SEM40X60 C	M20 CLAMP SCREW SEM40	DR.DOG 16X18S	SR M6X20 DIN912	WRENCH M20 SEMC 40*

* Optional, bitte separat bestellen.

BT-SEM-C

ISO 3937 Aufsteckfräserdorne mit Innenkühlung, Form ADB

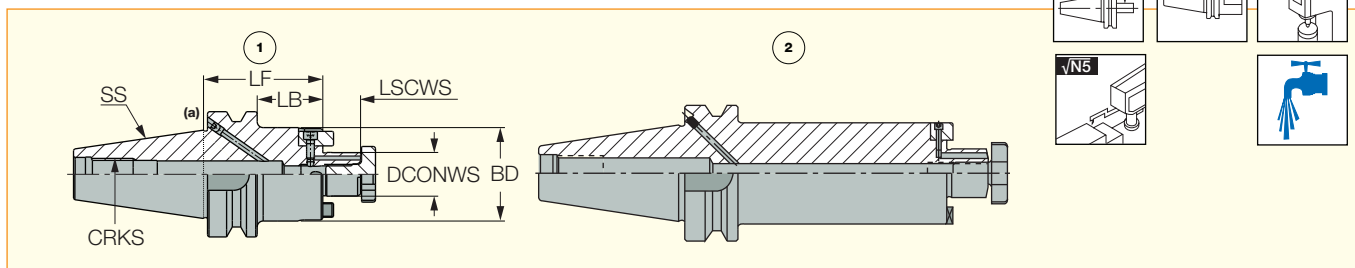
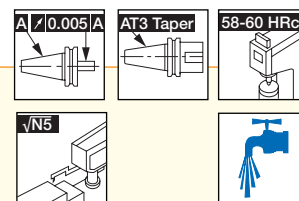





Bezeichnung	SS	DCONWS	BD	LF	LSCWS	LB	CRKS	kg	Abb.
BT40 SEM 16X60C	40	16.00	38.00	60.00	17.00	33.0	M16	1.21	1.
BT40 SEM 16X100C	40	16.00	38.00	100.00	17.00	73.0	M16	1.57	1.
BT40 SEM 22X60C	40	22.00	47.00	60.00	19.00	33.0	M16	1.10	1.
BT40 SEM 22X100C	40	22.00	47.00	100.00	19.00	73.0	M16	2.03	1.
BT40 SEM 27X45C	40	27.00	58.00	45.00	21.00	18.0	M16	1.32	1.
BT40 SEM 27X100C	40	27.00	58.00	100.00	21.00	73.0	M16	2.44	1.
BT40 SEM 32X60C	40	32.00	66.00	60.00	24.00	33.0	M16	1.84	1.
BT40 SEM32X78X60C	40	32.00	78.00	60.00	24.00	33.0	M16	2.20	1.
BT40 SEM32X78X100C	40	32.00	78.00	100.00	24.00	73.0	M16	3.36	1.
BT50 SEM 16X75C	50	16.00	38.00	75.00	17.00	37.0	M24	3.82	1.
BT50 SEM 16X100C	50	16.00	38.00	100.00	17.00	62.0	M24	4.00	1.
BT50 SEM 22X75C	50	22.00	47.00	75.00	19.00	37.0	M24	4.00	1.
BT50 SEM 22X100C	50	22.00	47.00	100.00	19.00	62.0	M24	4.30	1.
BT50 SEM 22X48X220C ⁽¹⁾	50	22.00	48.00	220.00	19.00	182.0	M24	5.98	2.
BT50 SEM 22X61X320C ⁽¹⁾	50	22.00	61.00	320.00	19.00	282.0	M24	9.91	2.
BT50 SEM 27X60C	50	27.00	58.00	60.00	21.00	22.0	M24	3.96	1.
BT50 SEM 27X100C	50	27.00	58.00	100.00	21.00	62.0	M24	4.72	1.
BT50 SEM 27X61X320C ⁽¹⁾	50	27.00	61.00	320.00	21.00	282.0	M24	9.78	2.
BT50 SEM 32X75C	50	32.00	66.00	75.00	24.00	37.0	M24	4.50	1.
BT50 SEM 32X100C	50	32.00	66.00	100.00	24.00	62.0	M24	5.04	1.
BT50 SEM32X78X50C	50	32.00	78.00	50.00	24.00	12.0	M24	4.16	1.
BT50 SEM32X78X100C	50	32.00	78.00	100.00	24.00	62.0	M24	5.99	1.
BT50 SEM 32X78X390C ⁽¹⁾	50	32.00	78.00	390.00	24.00	352.0	M24	16.66	2.

NEU
NEU

NEU
NEU

• (a) Wenn Typ B benötigt wird, muss die Verschlusschraube für Kühlung durch den Aufnahmeflansch entfernt werden (hierfür einen 2 mm Sechskantschlüssel verwenden).

⁽¹⁾ Symmetrisches Design.

Ersatzteile					
Bezeichnung	Klemmschraube	Spannschlüssel	Drive Dog	Schraube	Spannschlüssel 1
BT40 SEM 16X60C	M8 CLAMP SCREW SEM16	WRENCH M8 SEMC16*	DR.DOG 85	SR M3X10 DIN912	SR M4X4 DIN913
BT40 SEM 16X100C	M8 CLAMP SCREW SEM16	WRENCH M8 SEMC16*	DR.DOG 85	SR M3X10 DIN912	SR M4X4 DIN913
BT40 SEM 22X60C	M10 CLAMP SCREW SEM22	WRENCH M10 SEMC 22*	DR.DOG 105	SR M4X10 DIN912	SR M4X4 DIN913
BT40 SEM 22X100C	M10 CLAMP SCREW SEM22	WRENCH M10 SEMC 22*	DR.DOG 105	SR M4X10 DIN912	SR M4X4 DIN913
BT40 SEM 27X45C	M12 CLAMP SCREW SEM27	WRENCH M12 SEMC 27*	DR.DOG 125	SR M5X14 DIN912	SR M4X4 DIN913
BT40 SEM 27X100C	M12 CLAMP SCREW SEM27	WRENCH M12 SEMC 27*	DR.DOG 125	SR M5X14 DIN912	SR M4X4 DIN913
BT40 SEM 32X60C	M16 CLAMP SCREW SEM32	WRENCH M16 SEMC 32*	DR.DOG 14X13S	SR M5X14 DIN912	SR M4X4 DIN913
BT40 SEM32X78X60C	M16 CLAMP SCREW SEM32	WRENCH M16 SEMC 32*	DR.DOG 14X13S	SR M5X14 DIN912	SR M4X4 DIN913
BT40 SEM32X78X100C	M16 CLAMP SCREW SEM32	WRENCH M16 SEMC 32*	DR.DOG 14X13S	SR M5X14 DIN912	SR M4X4 DIN913
BT50 SEM 16X75C	M8 CLAMP SCREW SEM16	WRENCH M8 SEMC16*	DR.DOG 85	SR M3X10 DIN912	SR M4X4 DIN913
BT50 SEM 16X100C	M8 CLAMP SCREW SEM16	WRENCH M8 SEMC16*	DR.DOG 85	SR M3X10 DIN912	SR M4X4 DIN913
BT50 SEM 22X75C	M10 CLAMP SCREW SEM22	WRENCH M10 SEMC 22*	DR.DOG 105	SR M4X10 DIN912	SR M4X4 DIN913
BT50 SEM 22X100C	M10 CLAMP SCREW SEM22	WRENCH M8 SEMC16*	DR.DOG 105	SR M4X10 DIN912	SR M4X4 DIN913
BT50 SEM 22X48X220C	M10 CLAMP SCREW SEM22	WRENCH M10 SEMC 22*	DR.DOG 105	SR M4X10 DIN912	SR M4X4 DIN913
BT50 SEM 22X61X320C	M10 CLAMP SCREW SEM22	WRENCH M10 SEMC 22*	DR.DOG 105	SR M4X10 DIN912	SR M4X4 DIN913
BT50 SEM 27X60C	M12 CLAMP SCREW SEM27	WRENCH M12 SEMC 27*	DR.DOG 125	SR M5X14 DIN912	SR M4X4 DIN913
BT50 SEM 27X100C	M12 CLAMP SCREW SEM27	WRENCH M12 SEMC 27*	DR.DOG 125	SR M5X14 DIN912	SR M4X4 DIN913
BT50 SEM 27X61X320C	M12 CLAMP SCREW SEM27	WRENCH M12 SEMC 27*	DR.DOG 125	SR M5X12 DIN912	SR M4X4 DIN913
BT50 SEM 32X75C	M16 CLAMP SCREW SEM32	WRENCH M16 SEMC 32*	DR.DOG 14X13S	SR M5X14 DIN912	SR M4X4 DIN913
BT50 SEM 32X100C	M16 CLAMP SCREW SEM32	WRENCH M16 SEMC 32*	DR.DOG 14X13S	SR M5X14 DIN912	SR M4X4 DIN913
BT50 SEM32X78X50C	M16 CLAMP SCREW SEM32	WRENCH M16 SEMC 32*	DR. DOG 14 E	SR M5X14 DIN912	SR M4X4 DIN913
BT50 SEM32X78X100C	M16 CLAMP SCREW SEM32	WRENCH M16 SEMC 32*	DR.DOG 14X13S	SR M5X14 DIN912	SR M4X4 DIN913
BT50 SEM 32X78X390C	M16 CLAMP SCREW SEM32	WRENCH M16 SEMC 32*	DR.DOG 14X16S	SR M5X20 DIN912	SR M4X4 DIN913

* Optional, bitte separat bestellen.

Preisliste

Artikel-Nr.	Bezeichnung	Preis €	Verfügbarkeit
3372754	C8 SEM32X78X100C	295,00	ab Lager
3372752	C8 SEM32X78X50C	295,00	ab Lager
3372724	DIN69871 40 SEM32X78X100C	162,00	ab Lager
3372723	DIN69871 40 SEM32X78X50C	147,00	ab Lager
3372728	DIN69871 50 SEM32X78X100C	225,00	ab Lager
3372725	DIN69871 50 SEM32X78X50C	194,00	ab Lager
4505153	DIN69871 50 SEM32X78X370C	829,00	ab Lager
3372731	HSK A63 SEM32X78X100C	230,00	ab Lager
3372730	HSK A63 SEM32X78X60C	209,00	ab Lager
3372733	HSK A100 SEM32X78X100C	365,00	ab Lager
3372735	HSK A100 SEM32X78X60C	276,00	ab Lager
3372747	BT40 FC SEM32X78X60C	193,00	ab Lager
3372751	BT50 FC SEM32X78X60C	252,00	ab Lager
3372738	BT40 SEM32X78X100C	162,00	ab Lager
3372737	BT40 SEM32X78X60C	147,00	ab Lager
3372743	BT50 SEM32X78X100C	256,00	ab Lager
3372745	BT50 SEM32X78X50C	224,00	ab Lager

Rabattgruppe: J2 ITS AUFN+SPANNZ